

# **RIGOL**

用户手册

## **PVA8000 系列有源探头**

**2023 年 01 月**

**RIGOL TECHNOLOGIES CO., LTD.**

# 保证和声明

## 版权

© 2022 普源精电科技股份有限公司

## 商标信息

**RIGOL**®是普源精电科技股份有限公司的英文名称和商标

## 文档编号

UGE34001-1110

## 声明

- 公司产品受已获准及尚在审批的中华人民共和国专利的保护。
- 本公司保留改变规格及价格的权利。
- 本手册提供的信息取代以往出版的所有资料。
- 对于本手册可能包含的错误，或因手册所提供的信息及演绎的功能，以及因使用本手册而导致的任何偶然或继发的损失，**RIGOL** 概不负责。
- 未经 **RIGOL** 事先书面许可不得复印复制或改编本手册的任何部分。

## 产品认证

**RIGOL** 认证本产品符合中国国家产品标准和行业产品标准及 ISO9001:2015 标准和 ISO14001:2015 标准，并进一步认证本产品符合其它国际标准组织成员的相关标准。

## 联系我们

如您在使用此产品或本手册的过程中有任何问题或需求，可与 **RIGOL** 联系：

电子邮箱：[service@rigol.com](mailto:service@rigol.com)

网址：[www.rigol.com](http://www.rigol.com)

# 安全术语和符号

本手册中的安全术语。



## 警告

警告性声明指出可能会造成人身伤害或危及生命安全的情况或操作。



## 注意

注意性声明指出可能导致本产品损坏或数据丢失的情况或操作。

产品上的安全术语。

### DANGER

表示您如果不进行此操作，可能会立即对您造成危害。

### WARNING

表示您如果不进行此操作，可能会对您造成潜在的危害。

### CAUTION

表示您如果不进行此操作，可能会对本产品或连接到本产品的其他设备造成损坏。

产品上的安全符号。



高电压



安全警告



保护性接地端



壳体接地端



测量接地端

# 文档概述

本手册用于指导用户快速了解 PVA8000 系列有源探头及其使用方法，并提供保养与清洁等服务信息。

PVA8000 系列有源探头包含如下型号。

型号	带宽
PVA8350	>3.5GHz
PVA8700	>7GHz

主要内容包括：

- **PVA8000 系列有源探头概述**  
简介探头，包括：一般性检查、探头尺寸、标准附件等。
- **PVA8000 系列有源探头的使用方法**  
介绍如何使用探头，包括：连接示波器、使用探头前端、更换探头配件、调节偏移电压、校准探头等。
- **保养与清洁**
- **保修概要**
- **性能指标**

# 目录

保证和声明 .....	I
安全术语和符号 .....	II
文档概述 .....	III
<b>PVA8000 系列有源探头概述 .....</b>	<b>1</b>
探头简介 .....	2
一般性检查 .....	3
探头尺寸 .....	4
附件和选件 .....	5
有源探头放大器 .....	7
探头前端 .....	8
<b>PVA8000 系列有源探头的使用方法 .....</b>	<b>13</b>
连接示波器 .....	14
使用探头前端 .....	16
更换探头配件 .....	22
调节偏移电压 .....	23
校准探头 .....	24
<b>保养与清洁 .....</b>	<b>25</b>
<b>保修概要 .....</b>	<b>26</b>
<b>性能指标 .....</b>	<b>27</b>

---

# PVA8000 系列有源探头概述

本部分指导用户快速了解 PVA8000 系列有源探头。

主要包括：

- 探头简介
- 一般性检查
- 探头尺寸
- 附件和选件
- 有源探头放大器
- 探头前端

## 探头简介

PVA8000是一款带宽高于7GHz，针对于高频解决方案的有源探头。它可以测量差分信号和单端信号，并具有良好的共模抑制效果。PVA8000使用快插式探头前端，支持五种探头前端相互更换，从而适应多种使用场景，提高了探头可用性。允许用户更换探头尖，延长探头的使用寿命。探头尖的间距可精细调节以适应不同的待测点间距。

PVA8000与**RIGOL DS70000**系列示波器的自动识别接口兼容，可由该接口自动识别和配置。其卡入式BNC连接器使得与示波器的连接更加方便。

PVA8000提供丰富的附件和选件，并且诸多部件采用可替换的设计原则，可方便地应用于不同的测试测量解决方案。

---

## 一般性检查

### 1. 检查运输包装

如运输包装已损坏，请保留被损坏的包装或防震材料，直到货物经过完全检查且探头通过电性和机械测试。

因运输造成探头损坏，由发货方和承运方联系赔偿事宜。**RIGOL** 公司恕不进行免费维修或更换。

### 2. 检查探头

若存在机械损坏或缺失，或者探头未通过电性和机械测试，请联系您的 **RIGOL** 经销商。

### 3. 检查附件

请根据本手册**附件和选件**一节检查随机附件，如有损坏或缺失，请联系您的 **RIGOL** 经销商。



# 探头尺寸

图 1 给出了 PVA8000 系列有源探头主体部分的尺寸示意图。



图 1 探头尺寸

## 附件和选件

本节列出了 PVA8000 系列有源探头套件及其标准附件。所列部件均可通过 **RIGOL** 订购。

- PVA8700 有源探头套件包含表 1 所列全部标准附件。如需单独订购附件或选件，请参考表 1。
- PVA8350 有源探头套件包含表 2 所列全部标准附件。如需单独订购附件或选件，请参考表 2。

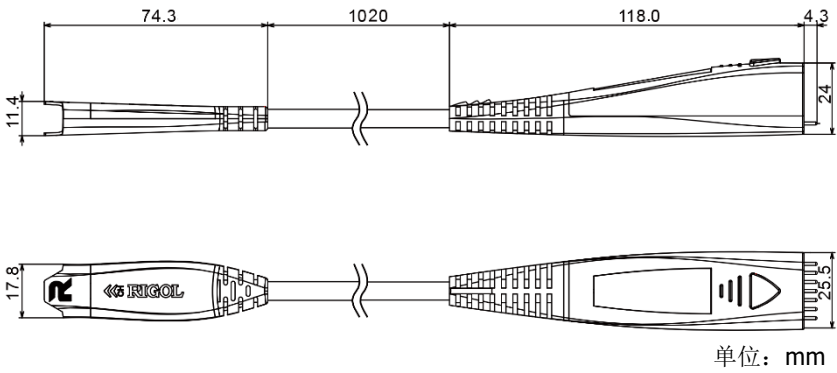
表 1 PVA8700 有源探头套件标准附件

名称	数量
PVA8700 有源探头放大器	1
焊接式差分探头前端	1
焊接式单端探头前端	1
手持式差分探头前端	1
手持式单端探头前端	1
插座式差分探头前端	1
0.2mm 镍丝	1
修剪标尺	1
接地端针尖（手持式单端）	4 种（每种 3 套）
信号端针尖（手持式单端）	3 种（每种 3 套）
探头尖（手持式差分）	1 种（共 3 套）
用户手册	1
储物盒	1
探头箱	1

表 2 PVA8350 有源探头套件标准附件

名称	数量
PVA8350 有源探头放大器	1
焊接式差分探头前端	1
焊接式单端探头前端	1
手持式差分探头前端	1
手持式单端探头前端	1
插座式差分探头前端	1
0.2mm 镍丝	1
修剪标尺	1
接地端针尖（手持式单端）	4 种（每种 3 套）
信号端针尖（手持式单端）	3 种（每种 3 套）
探头尖（手持式差分）	1 种（共 3 套）
用户手册	1
储物盒	1
探头箱	1

**注意：**本部分所列附件仅供参考，请以产品实物为准。

## 有源探头放大器

有源探头放大器（图 2）作为有源探头的主体部件，具有大于 7GHz 的带宽，它一端可与示波器（如 DS70000 系列）连接，另一端可灵活插入用户所需的探头前端。



图 2 有源探头放大器

有源探头放大器与探头前端通过插拔方式进行连接。在插拔的过程中，请注意放大器端和探头前端的弹簧片方向，务必使弹簧片同侧连接。弹簧片接反会造成有源探头性能下降甚至损坏探头。

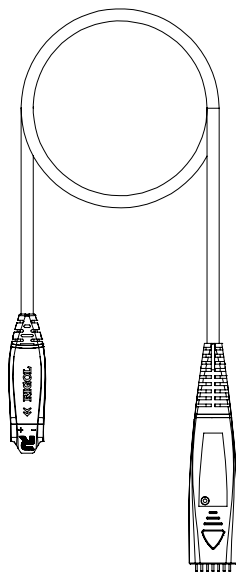

### 注意

焊接式单端探头前端的负极带有黑色标识套。

# 探头前端

PVA8000 支持**手持式探头前端**、**焊接式探头前端**和**插座式探头前端**。

## 1. 手持式探头前端

手持式探头前端的类型为：**手持式差分探头前端**和**手持式单端探头前端**。

使用此类探头前端，如同使用普通无源探头，您可以方便的测量信号。此外，探头尖间距可方便的调节以满足您不同的测量需求。

对于手持式差分探头前端，探头尖的间距由探头前端上的拨轮控制。前后拨动该拨轮便可精确调节两个探头尖的间距，如图 3 所示。



图 3 手持式差分探头前端

其中，探头尖是标准附件，如图 4 所示，是可替换部件。如果在使用过程中被损坏，您可以方便地更换新的探头尖，更换方法请参考**更换探头配件**。

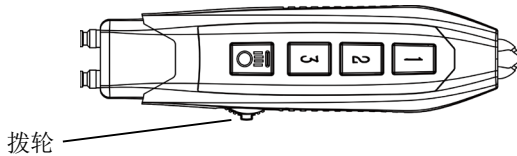

图 4 探头尖

对于手持式单端探头前端，旋转单端接地端针尖以改变接地端针尖与探头尖的距离，如图 5 所示。

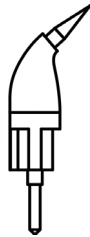

图 5 手持式单端探头前端

其中信号端针尖与接地端针尖是标准附件，均为可替换部件，具有多个系列，在使用时可以根据不同的使用场景的需求进行搭配更换，更换方法请参考**更换探头配件**。

PVA8000 系列探头提供 3 种信号端针尖和 4 种接地端针尖以适应不同的测量要求，各针尖的结构如图 6 所示。信号端针尖和接地端针尖可根据测试需求自由组合使用。

#### 信号端针尖

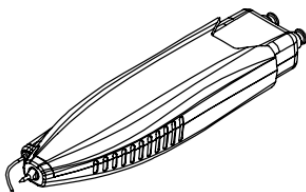
- a)信号端弯针尖（与手持差分前端针尖相同可通用）：适用于近距离测试点的手持点测。
- b)信号端直针尖：适用于近距离测试点的手持点测。
- c)信号端方形插孔式针尖：配合插接公头杜邦线，适用于较远距离测试点的测量；或配合接地端方形插孔式针尖，适用于直插电路板排针测试。

#### 接地端针尖

- d)接地端弹性针尖：适用于近距离测试点的手持点测。
- e)接地端可焊接针尖：适用于较远距离测试点的手持点测或焊接测试。
- f)接地端方形插孔式针尖：配合信号端方形插孔式针尖，适用于直插电路板排针测试。
- g)接地端方形插孔式直角针尖：配合插接公头杜邦线，适用于较远距离测试点的

测量。

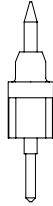

(a) 信号端弯针尖 (b) 信号端直针尖 (c) 信号端方形插孔式针尖

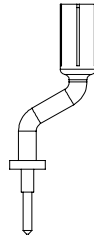
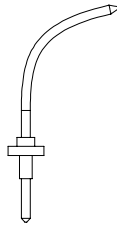
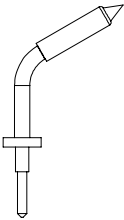

(d) 接地端弹性针尖 (e) 接地端可焊接针尖 (f) 接地端方形插孔式针尖

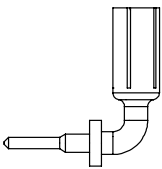

(g) 接地端方形插孔式直角针尖

图 6 信号端针尖与接地端针尖类型

## 2. 焊接式探头前端

焊接式探头前端包括两种类型：**焊接式差分探头前端**和**焊接式单端探头前端**，见

图 7 和图 8。其中，焊接式探头前端适合测量高密度 IC 管脚的信号。



图 7 焊接式差分探头前端



图 8 焊接式单端探头前端

焊接式单端探头前端具有负极标识套的同端引脚用于接地。

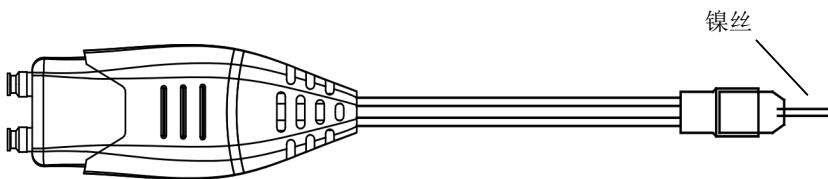
使用此类探头前端进行测量时，建议使用辅助装置固定探头前端。

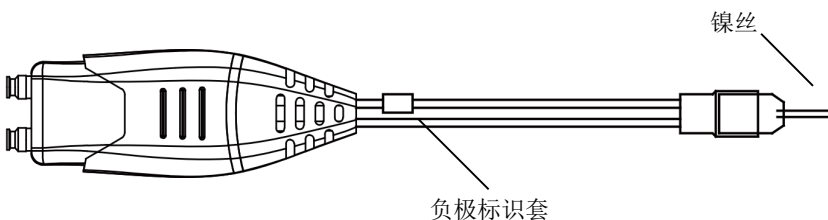

### 注意

用手固定探头前端容易造成探头前端焊接引线电阻线的断裂或脱落，且手握的位置会对探头的性能有一定的影响！

其中，焊接式探头前端的镍丝是标准附件，若在使用过程中被损坏，您可以参考[更换探头配件](#)一节进行更换。

### 3. 插座式差分探头前端

插座式探头前端适合测量间距为 2.54mm 的双排针引出信号。





图 9 插座式差分探头前端

使用插座式差分探头前端进行测量时，请注意使用辅助装置固定探头前端。注意，请勿使用手固定探头前端，否则容易造成探头前端的插座接触不良，且手握的位置也可能影响探头的性能。

# PVA8000 系列有源探头的使用方法

在使用 PVA8000 系列有源探头的过程中，正确的使用方法可以保证探头性能，延长探头的使用寿命并保证信号测量结果的有效性。本部分将详细介绍 PVA8000 系列有源探头的使用方法。

主要包括：

- 连接示波器
- 使用探头前端
- 更换探头配件
- 调节偏移电压
- 校准探头

## 连接示波器

PVA8000 系列有源探头与 RIGOL DS70000 系列示波器正确连接后，示波器自动识别探头并通过前面板为探头提供电源和偏移电压。此时，您可以通过示波器前面板菜单调节偏移电压（参考**调节偏移电压**一节）和校准探头（参考**校准探头**一节）等操作。

请按照如下步骤连接探头与示波器：

1. 将探头前端（图中以手持式差分探头前端为例）与有源探头放大器连接。

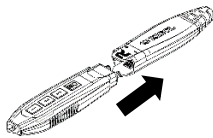

2. 将有源探头放大器的另一端连接到示波器通道输入连接器，并推到紧闭的位置。

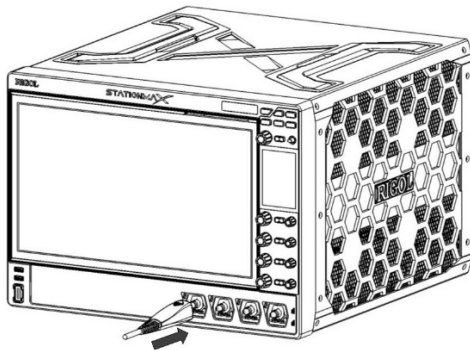

3. 使用任意探头辅助装置将其连接到待测电路中。

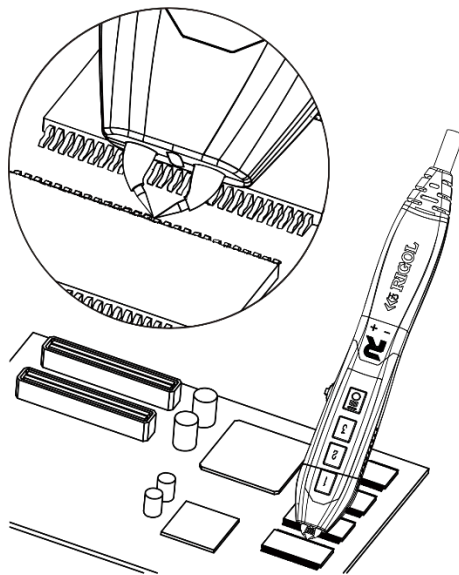

4. 需断开探头和示波器的连接时，首先按住探头上的按钮（见左下图），将连接器从示波器拔出后（见右下图），松开按钮即可。

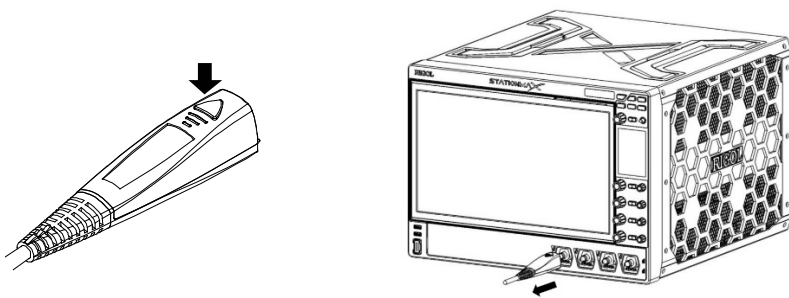

### 注意

不要试图从示波器 BNC 连接器上扭动探头，否则，可能导致探头损坏。

## 使用探头前端

由**探头前端**一节可知，PVA8000 系列可连接 5 种不同类型的探头前端。您可以参考**更换探头配件**一节所述方法更换探头前端。本节分别介绍以下类型探头前端的使用方法。

### 1. 手持式差分探头前端

手持式差分探头前端的有效带宽大于 7GHz，两路探头尖的间距可以通过拨轮进行精细调节，也可以通过按探头前端上的按钮进行记忆性调节，探头尖允许更换，从而延长探头的使用寿命。

手持式差分探头前端结构如图 10 所示。





图 10 手持式差分探头前端

- ① 拨动拨轮调节两个探头尖的间距（0.2mm 至 5.4mm）。
- ② 手持式差分探头前端。
- ③ 探头尖。

使用手持式差分探头前端，您可以方便的测量差分信号和单端信号。探头前端上的按钮 1、2、3 都可实现记忆功能。以按钮 1 为例，当使用时需要对探头尖的现有位置进行保存以便后续使用时，可在此位置长按该按钮，等到探头尖之间的照明灯闪烁时松开按钮，这样便实现了对该探头尖位置的记忆存储。在后续的使用中，通过按该按钮，即可使探头尖自动旋转至该位置。 按钮为探头尖照明灯的开关按钮，可用于弱光环境下的测量。

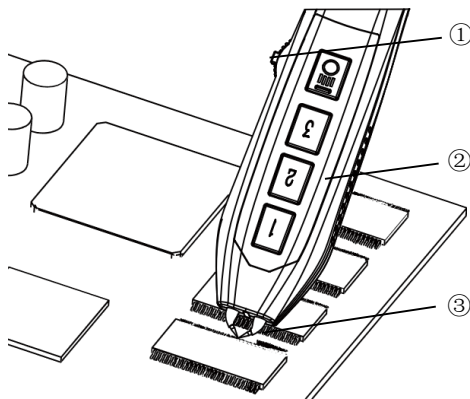
具体操作方法如下图所示：



图 11 手持式差分探头前端操作演示图

## 2. 手持式单端探头前端

手持式单端探头前端的有效带宽大于 7GHz，探头信号端针尖与单端接地针尖的间距可以通过拨动或旋转单端接地针进行调节。信号端针尖（手持式单端）和接地端针尖（手持式单端）允许更换，从而提高了探头的易用性，并延长探头的使用寿命。

手持式单端探头前端结构如图 12 所示。

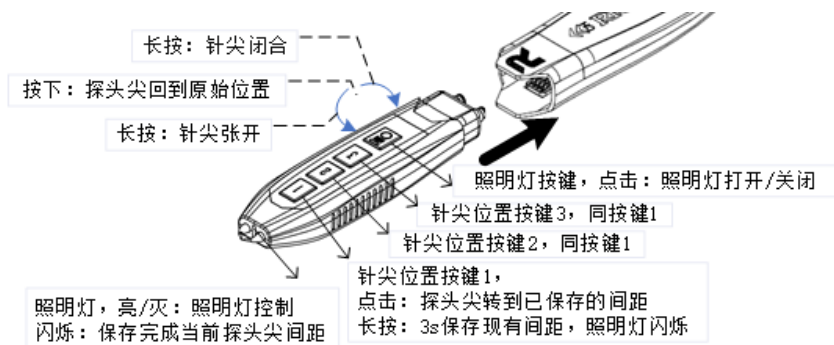

图 12 手持式单端探头前端

### 3. 焊接式差分探头前端

焊接式差分探头前端的有效带宽大于 7GHz，允许用户更换镍丝，从而提高了探头的易用性，并延长了探头的使用寿命。

焊接式差分探头前端结构如图 13 所示。

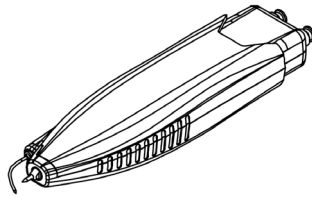

图 13 焊接式差分探头前端

- ① 焊接式差分探头前端。
- ② 0.2mm 镍丝（长度 4 mm 典型值）。

当待测点间距较远时，镍丝长度加长，会导致测试信号产生过冲和振铃，高频响

应发生变化。

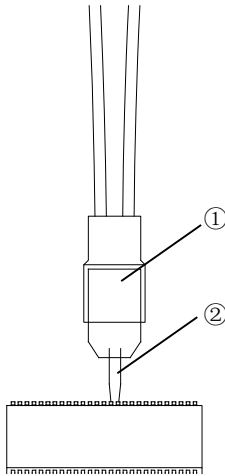
#### 4. 焊接式单端探头前端

焊接式单端探头前端的有效带宽大于 5GHz，允许用户更换镍丝，从而提高了探头的易用性，并延长了探头的使用寿命。

焊接式单端探头前端结构如图 14 所示。位于负极标识套（见“图 8”）同一侧的引脚为负极。



图 14 焊接式单端探头前端

- ① 焊接式单端探头前端。
- ② 0.2mm 镍丝（长度 4 mm 典型值）。

当待测点距离较远时，镍丝长度加长，会导致测试信号产生过冲和振铃，高频响应应发生变化。

#### 5. 插座式差分探头前端

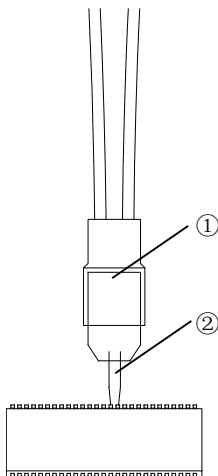

插座式差分探头前端的有效带宽大于 4GHz，并且插拔方便，使用寿命长。

插座差分探头前端结构如图 15 所示。



图 15 插座式差分探头前端

- ① 插座式差分探头前端。
- ② 插座。

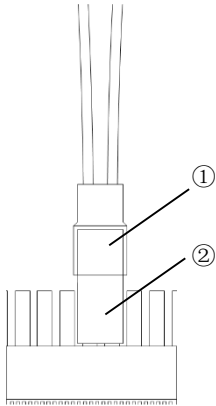

# 更换探头配件

## 1. 更换探头前端

更换过程中请小心操作，以免破坏连接部分而影响探头的性能。

更换方法：

- ① 断开探头和示波器的连接。
- ② 断开探头前端与有源探头放大器的连接。
- ③ 将新的探头前端垂直插入有源探头放大器。连接时，请保持弹簧片同侧相连。

## 2. 更换探头尖

探头尖与探头前端以直插的方式进行连接，拆卸和安装探头尖时请注意直插的方向和力度。

## 3. 更换镍丝

使用过程中，如果焊接式探头前端镍丝损坏或脱落，您可以更换新的镍丝。镍丝需要满足如下尺寸要求，即长度为 4mm（推荐值）。

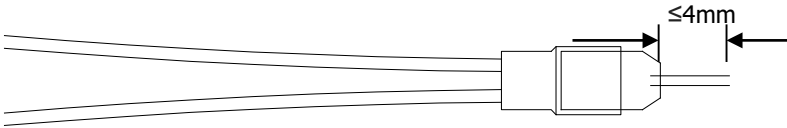

注意：当镍丝长度大于 4mm 时，会影响探头带宽指标。镍丝长度可以使用修剪标尺进行裁剪和测量。

## 调节偏移电压

**RIGOL DS70000** 系列示波器系统为 **PVA8000** 系列有源探头提供偏移电压控制信号，由探头的 **BNC** 模块输出偏移电压。此偏移电压控制信号用于将超出有源探头放大器输入动态范围的被测信号调整至适当的范围，以保证被测信号的完整性。

此偏移电压可通过示波器前面板菜单进行调节。调整方法如下：

1. 按照**连接示波器**一节所述方法，将 **PVA8000** 系列有源探头连接至 **DS70000** 系列示波器的通道输入端（比如：**CH1**）。
2. 打开 **DS70000** 示波器的探头偏移电压控制菜单（**CH1** → **探头** → **偏置**），使用虚拟键盘输入偏移电压值。

## 校准探头

在使用 PVA8000 系列有源探头前，您需要对探头进行校准。校准步骤如下：

1. 连接 PVA8000 有源探头至示波器的模拟通道（CH1-CH4，本文以 CH1 为例进行说明）。
2. 打开示波器的探头校准控制菜单操作：**CH1** → **探头** → **探头校准**，示波器自动对探头零点进行校准，探头校准的时间大约 80~90 秒，探头校准完成时示波器会根据校准结果弹出“探头校准完成”或“探头校准失败”提示信息。

由于 PVA8000 系列有源探头的偏移电压值由 BNC 模块进行提供，因此在第一次完成校准之后，下次使用前无需再进行校准。

注意：PVA8000 系列有源探头相关的性能指标依赖于探头的校准。完成校准后，有源探头的直流增益、偏移电压零点和偏移增益均被校准。插入探头后，用户可以通过菜单 **CH1** → **探头**，在探头设置菜单中查看探头的厂商、型号、序列号和上次校准时间等信息。

## 保养与清洁

### 保养：

请勿将探头及其附件放置在长时间受到日照的地方。



### 注意

请勿使任何腐蚀性的液体沾到探头及其附件上。

### 清洁：

请根据使用情况经常对探头及其附件进行清洁。方法如下：

1. 断开探头与示波器或电源的连接。
2. 用潮湿但不滴水的软布（可使用柔和的清洁剂或清水）擦拭探头及其附件外部的浮尘。



### 警告

在重新使用前，请确认探头已经干透，避免因水分造成电气短路甚至人身伤害。

## 保修概要

普源精电科技股份有限公司（**RIGOL TECHNOLOGIES CO., LTD.**以下简称**RIGOL**）承诺其产品在保修期内无任何材料和工艺缺陷。在保修期内，若产品被证明有缺陷，**RIGOL** 将为用户免费维修或更换。

详细保修条例请参见 **RIGOL** 官方网站或产品保修卡的说明。欲获得维修服务或保修说明全文，请与 **RIGOL** 维修中心或当地办事处联系。

除本概要或其他适用的保修卡所提供的保证以外，**RIGOL** 公司不提供其他任何明示或暗示的保证，包括但不限于对产品可交易性和特殊用途适用性之任何暗示保证。在任何情况下，**RIGOL** 公司对间接的、特殊的或继起的损失不承担任何责任。

# 性能指标

## 技术指标

指标名称	PVA8350	PVA8700
带宽	>3.5GHz	>7GHz
上升时间	110ps (典型值)	70ps (典型值)
系统带宽	3.5GHz <sup>[1]</sup>	5GHz <sup>[1]</sup>
输入电容	<0.6pF	
输入电阻	50kΩ±2% 差分模式	
	25kΩ±4% 单端模式	
输入动态范围	±2V	
输入共模范围	±6.25V DC~100Hz	
	±1.25V >100Hz	
共模抑制比	>40dB@1MHz	>40dB@1MHz
	>26dB@1GHz	>26dB@1GHz
	>22dB@3GHz	>20dB@4GHz
信号最大压摆率 <sup>[2]</sup>	18V/ns 单端模式	
	30V/ns 差分模式	
直流衰减精度	10:1 ±2%	
零点偏移误差 <sup>[3]</sup>	<30mV 校准前	
	<5mV 校准后	
偏移精度 <sup>[3]</sup>	<3%当前量程 校准前	
	<1%当前量程 校准后	
输入噪声	5mVrms	
传输延迟	6ns (典型值)	
最大输入电压	30V Peak CAT I <sup>[4]</sup>	
静电防护 (HBM)	>8kV	



## 一般规格

环境条件	操作环境	存放环境
温度	+5°C ~+40°C	-40°C ~+60°C
湿度	0 RH~80% RH	0 RH~90% RH
海拔	4600m	15300m
功耗	1.35W	N/A
重量	137±10g <sup>[5]</sup>	736±50g <sup>[6]</sup>
线长	1m	

- [1] 与 DS70000 系列产品级联时的系统带宽。
- [2] 正弦信号  $SR_{max}=2 \times \text{幅度} \times \text{频率}$ ；阶跃信号  $SR_{max}=0.6 \times \text{幅度} / \text{上升时间}$  (20~80%)。
- [3] 典型值，其技术指标会随着示波器的档位不同而改变。
- [4] CAT I 和 CAT II 的定义  
 装置种类（超压种类）I：信号电平，特殊设备或部分设备，无线电通讯和电子等，相对装置种类（超压种类）II 有更小的瞬态电压。  
 装置种类（超压种类）II：局部电平，器具，可携带设备等，相对装置种类（超压种类）III 有更小的瞬态电压。
- [5] PVA8000 配备手持式差分前端时的重量。
- [6] PVA8000 有源探头套件（含包装）的重量。



# **RIGOL**

## **User Guide**

### **PVA8000 Series Active Probe**

**Jan. 2023**

**RIGOL TECHNOLOGIES CO., LTD.**

# Guaranty and Declaration

## Copyright

© 2022 **RIGOL** TECHNOLOGIES CO., LTD. All Rights Reserved.

## Trademark Information

**RIGOL**® is the trademark of **RIGOL** TECHNOLOGIES CO., LTD.

## Publication Number

UGE34101-1110

## Notices

- **RIGOL** products are covered by P.R.C. and foreign patents, issued and pending.
- **RIGOL** reserves the right to modify or change parts of or all the specifications and pricing policies at the company's sole decision.
- Information in this publication replaces all previously released materials.
- Information in this publication is subject to change without notice.
- **RIGOL** shall not be liable for either incidental or consequential losses in connection with the furnishing, use, or performance of this manual, as well as any information contained.
- Any part of this document is forbidden to be copied, photocopied, or rearranged without prior written approval of **RIGOL**.

## Product Certification

**RIGOL** guarantees that this product conforms to the national and industrial standards in China as well as the ISO9001:2015 standard and the ISO14001:2015 standard. Other international standard conformance certifications are in progress.

## Contact Us

If you have any problem or requirement when using our products or this manual, please contact **RIGOL**.

E-mail: [service@rigol.com](mailto:service@rigol.com)

Website: [www.rigol.com](http://www.rigol.com)

# Safety Notices and Symbols

## Safety Notices in this Manual:



---

### **WARNING**

Indicates a potentially hazardous situation or practice which, if not avoided, will result in serious injury or death.

---



---

### **CAUTION**

Indicates a potentially hazardous situation or practice which, if not avoided, could result in damage to the product or loss of important data.

---

## Safety Terms on the Product:

**DANGER** It calls attention to an operation, if not correctly performed, could result in injury or hazard immediately.

**WARNING** It calls attention to an operation, if not correctly performed, could result in potential injury or hazard.

**CAUTION** It calls attention to an operation, if not correctly performed, could result in damage to the product or other devices connected to the product.

## Safety Symbols on the Product:



Hazardous  
Voltage



Safety  
Warning



Protective  
Earth  
Terminal



Chassis  
Ground



Test Ground

# Document Overview

This document is used to guide users to get a quick understanding of the PVA8000 series active probe as well as its using method. Besides, this document gives service information relating to care and cleaning.

PVA8000 series active probe includes the following models.

Model	Bandwidth
PVA8350	>3.5 GHz
PVA8700	>7 GHz

Main topics:

- **PVA8000 Series Overview**

This chapter gives a brief introduction of the probe, including general inspection, probe dimensions, standard accessories, and etc.

- **To Use PVA8000 Series Active Probe**

This chapter introduces how to use the probe, including how to connect to the oscilloscope, how to use the probe head, how to replace probe accessories, how to adjust the offset voltage, how to calibrate the probe, and etc.

- **Care and Cleaning**

- **Warranty**

- **Specifications**

# Contents

**Guaranty and Declaration ..... I**

**Safety Notices and Symbols ..... II**

**Document Overview ..... III**

**PVA8000 Series Overview ..... 1**

    Probe Introduction ..... 2

    General Inspection ..... 3

    Probe Dimensions ..... 4

    Accessories and Options ..... 5

    Active Probe Amplifier ..... 7

    Probe Head ..... 8

**To Use PVA8000 Series Active Probe ..... 14**

    To Connect to the Oscilloscope ..... 15

    To Use the Probe Head ..... 18

    To Replace Probe Accessories ..... 24

    To Adjust Offset Voltage ..... 25

    To Calibrate the Probe ..... 26

**Care and Cleaning ..... 27**

**Warranty ..... 28**

**Specifications ..... 29**

# PVA8000 Series Overview

This chapter guides users to quickly get familiar with the PVA8000 series active probe.

Main topics:

- Probe Introduction
- General Inspection
- Probe Dimensions
- Accessories and Options
- Active Probe Amplifier
- Probe Head



## **Probe Introduction**

PVA8000, with more than 7 GHz bandwidth, is an active probe for high frequency application. It can be used to measure differential and single-ended signals with better common mode rejection. PVA8000 uses plug-on socket probe head and supports five types of interchangeable probe heads to cater to different application scenarios, improving its usability. Besides, its replaceable probe tip prolongs the service life of the probe and the probe tip spacing can be precisely adjusted to fit different test point spacing.

PVA8000 is compatible with the auto-identification port of **RIGOL** DS70000 series oscilloscope and can be recognized and configured automatically. Its snap-in BNC connector enables easier connection with the oscilloscope.

PVA8000 provides various accessories and options, as well as multiple replaceable components which make it applicable to be used in different tests and measurements.

## General Inspection

### 1. **Inspect the packaging**

If the packaging has been damaged, do not dispose the damaged packaging or cushioning materials until the shipment has been checked for completeness and has passed both electrical and mechanical tests.

The consigner or carrier shall be liable for the damage to the instrument resulting from shipment. **RIGOL** would not be responsible for free maintenance/rework or replacement of the instrument.

### 2. **Inspect the instrument**

In case of any mechanical damage, missing parts, or failure in passing the electrical and mechanical tests, contact your **RIGOL** sales representative.

### 3. **Check the accessories**

Please check the accessories according to the packing lists. If the accessories are damaged or incomplete, please contact your **RIGOL** sales representative.

# Probe Dimensions

**Figure 1** shows the dimensions of the probe body of PVA8000 series active probe.

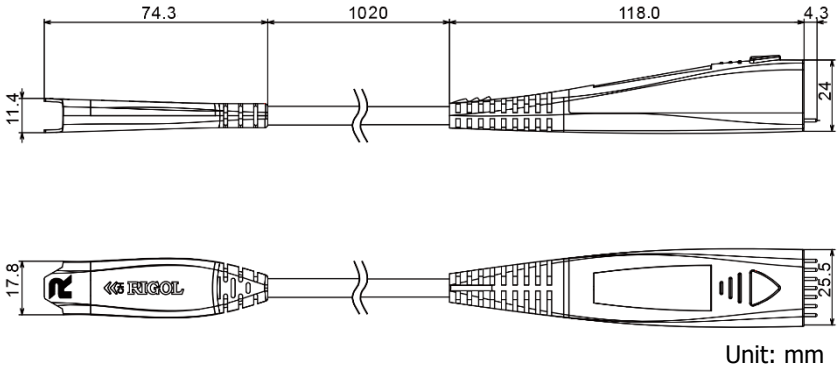

Figure 1 Probe Dimensions

## Accessories and Options

This section lists the probe kits and standard accessories of the PVA8000 series active probe respectively. All the components listed below can be ordered from **RIGOL**.

- PVA8700 Active Probe Kit contains all the accessories listed in **Table 1**. If any accessory or option needs to be ordered separately, please refer to **Table 1**.
- PVA8350 Active Probe Kit contains all the accessories listed in **Table 2**. If any accessory or option needs to be ordered separately, please refer to **Table 2**.

Table 1 PVA8700 Active Probe Kit Standard Accessories

Name	Qty.
PVA8700 Active Probe Amplifier	1
Solder-in Differential Probe Head	1
Solder-in Single-ended Probe Head	1
Hand-held Differential Probe Head	1
Hand-held Single-ended Probe Head	1
Differential Socketed Probe Head	1
0.2mm Nickel Wire	1
Trim Gauge	1
Ground Pin (Hand-held Single-ended)	4 types (3 pcs for each type)
Signal Pin (Hand-held Single-ended)	3 types (3 pcs for each type)
Probe Tip (Hand-held Differential)	1 type (3 pcs)
User Guide	1
Storage Box	1
Probe Bag	1

Table 2 PVA8350 Active Probe Kit Standard Accessories

<b>Name</b>	<b>Qty.</b>
PVA8350 Active Probe Amplifier	1
Solder-in Differential Probe Head	1
Solder-in Single-ended Probe Head	1
Hand-held Differential Probe Head	1
Hand-held Single-ended Probe Head	1
Differential Socketed Probe Head	1
0.2mm Nickel Wire	1
Trim Gauge	1
Ground Pin (Hand-held Single-ended)	4 types (3 pcs for each type)
Signal Pin (Hand-held Single-ended)	3 types (3 pcs for each type)
Probe Tip (Hand-held Differential)	1 type (3 pcs)
User Guide	1
Storage Box	1
Probe Bag	1

**Note:** The accessories listed in this section are only for reference, take the actual product as the standard.

## Active Probe Amplifier

The active probe amplifier (**Figure 2**), with more than 7 GHz bandwidth, is a main component of the active probe. One end of the active probe amplifier can be connected to the oscilloscope (e.g. DS70000 series) and the other end can be connected to the desired probe head.

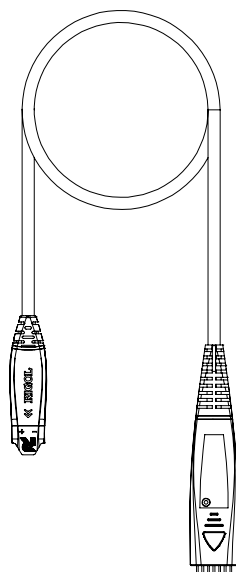

Figure 2 Active Probe Amplifier

When connecting a **probe head** to an **active probe amplifier**, push it straight in. When plugging in, make sure that the active probe amplifier is tightly connected to the probe head via the connection points. Pay attention to the spring direction, if connected in the wrong direction, the performance of the active probe will be undermined, even worse, the probe may be damaged.

**CAUTION**

There is a black mark sleeve on the negative pole of the solder-in single-ended probe head.

## Probe Head

PVA8000 supports **hand-held probe head**, **solder-in probe head**, and **socketed probe head**.

### 1. Hand-held Probe Head

The types of hand-held probe head include: **hand-held differential probe head** and **hand-held single-ended probe head**.

Like using common passive probes, you can use this kind of probe head to easily measure signals. Besides, the spacing between the probe tips can be easily adjusted to fulfill your various measurement requirements.

For hand-held differential probe head, the spacing between the probe tips is controlled by the roller on the probe head. As shown in **Figure 3**, turning the roller forwards or backwards can precisely adjust the spacing between the two probe tips.

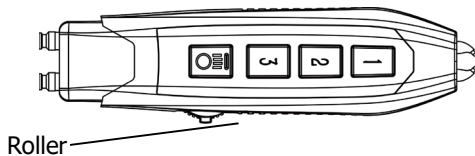

Figure 3 Hand-held Differential Probe Head

As shown in **Figure 4**, the probe tip is a standard accessory and replaceable. If it is damaged during use, you can easily replace it with a new one (refer to

**To Replace Probe Accessories).**

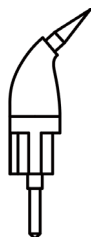

Figure 4 Probe Tip

For hand-held single-ended probe head, rotating the ground pin can adjust the spacing between the ground pin and probe tip, as shown in **Figure 5**.

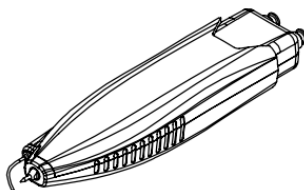

Figure 5 Hand-held Single-ended Probe Head

The signal pin and the ground pin are standard accessories. There are different types of signal pins and the ground pins, and they are replaceable. You can use them according to different application scenarios (refer to **To Replace Probe Accessories**).

PVA8000 series probe provides three types of signal pins and four types of ground pins to cater to different test requirements. The structure of the pins are shown in **Figure 6**. Different types of signal pins and ground pins can work with each other in different combination forms.

Signal Pin Types



- a) Signal Pin (bent): (same as the hand-held differential probe tip, available to use for any hand-held differential probe): suitable for carrying out the handheld spot test for near-distance test points.
- b) Signal Pin (straight): suitable for the hand-held spot test for near-distance test points.
- c) Signal Adapter (square pin): work with Male Dupont wires, suitable for measurements of a longer distance of test points; or work with square pin ground adapter, suitable for in-line circuit board pin tests.

**Ground Pin Types**

- d) Ground Pin (pogo): suitable for the hand-held spot test for near-distance test points.
- e) Ground Pin (solderable): suitable for the hand-held spot test for a longer distance of test points or soldering test.
- f) Ground Adapter (square pin): work with the signal square pin adapter, suitable for in-line circuit board pin tests.
- g) Ground Adapter (angled): works with male DuPont wires for measurements of a longer distance of test points.

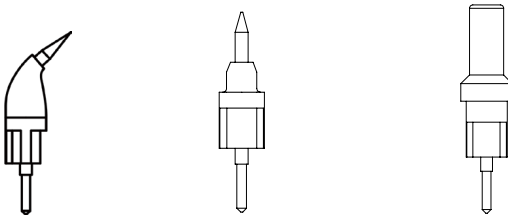

(a) Signal Pin (bent) (b) Signal Pin (straight) (c) Signal Adapter (square pin)

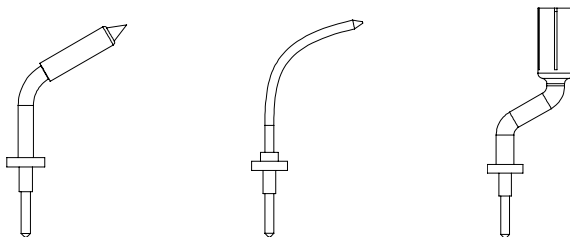

(d) Ground Pin (pogo) (e) Ground Pin (solderable) (f) Ground Adapter (square pin)

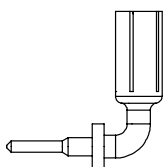

(g) Ground Adapter (angled)

Figure 6 Signal Pin Types and Ground Pin Types

## 2. Solder-in Probe Head

The solder-in probe head includes two types: **solder-in differential probe head** and **solder-in single-ended probe head**, as shown in **Figure 7** and **Figure 8**. Wherein, solder-in probe head is suitable for measurement of high-density IC pin signals.

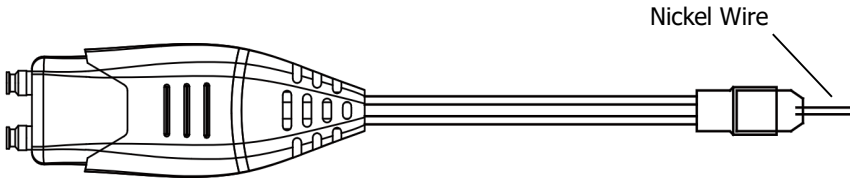

Figure 7 Solder-in Differential Probe Head

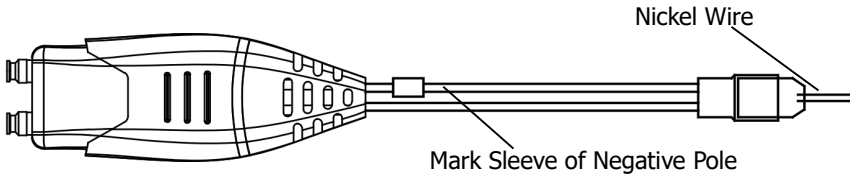

Figure 8 Solder-in Single-ended Probe Head

The pin that is at the same side of the mark sleeve is used to connect to the ground.

When using the solder-in probe head for measurement, we recommend you to use an auxiliary device to fix the probe head.



**CAUTION**

Using your hand to fix the probe head may cause the lead resistor soldered onto the probe head to break or fall off. The hand-held position might also affect the probe performance!

---

The nickel wire of the solder-in probe head is a standard accessory. If the nickel wire under use is damaged or broken, please replace it with a new one (refer to **To Replace Probe Accessories**).

### 3. Socketed Probe Head

The socketed probe head is suitable for measuring the 2.54 mm dual row pin

signal.



Figure 9 Differential Socketed Probe Head

When using the socketed probe head for measurement, please use the auxiliary device to fix the probe head. Do not use your hand to fix the probe head, otherwise the socket of the probe head will be poorly connected, and hand-held position might also affect the probe performance.

# To Use PVA8000 Series Active Probe

During the use of PVA8000 series active probe, correct operations can ensure the probe performance, prolong the service life of the probe and ensure the effectiveness of the signal measurement result. This chapter introduces in detail the using method of the PVA8000 series active probe.

Main Topics:

- To Connect to the Oscilloscope
- To Use the Probe Head
- To Replace Probe Accessories
- To Adjust Offset Voltage
- To Calibrate the Probe

## To Connect to the Oscilloscope

After PVA8000 is connected correctly to a **RIGOL** DS70000 series oscilloscope, the oscilloscope recognizes the probe automatically and provides both power and offset voltage to the probe. You can adjust the offset voltage (refer to **To Adjust Offset Voltage**) and calibrate the probe (refer to **To Calibrate the Probe**) by the front panel menu of the oscilloscope.

Please connect the probe to the oscilloscope following the steps below:

1. Connect the probe head (in the figure, taking a hand-held differential probe head for example) with the active probe amplifier.

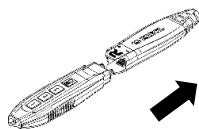

2. Connect the other end of the active probe amplifier to the channel input connector of the oscilloscope and make sure the connection is tight.

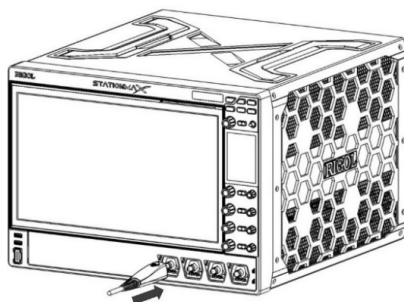

3. Use any probe auxiliary device to connect the probe to the circuit to be tested.

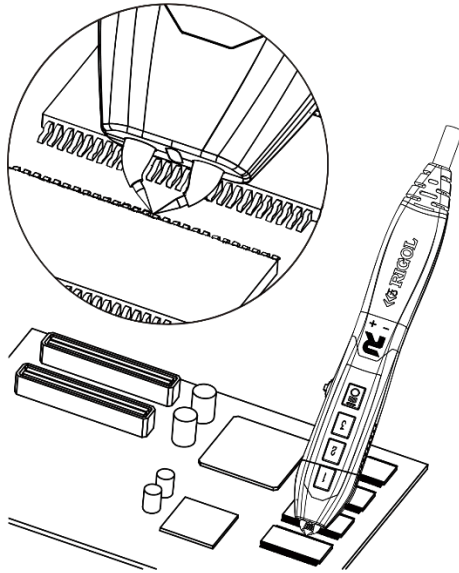

4. To disconnect the probe from the oscilloscope, press the button on the probe (as shown in the left figure below), pull the connector straight out of the oscilloscope (as shown in the right figure below) and then release the button.

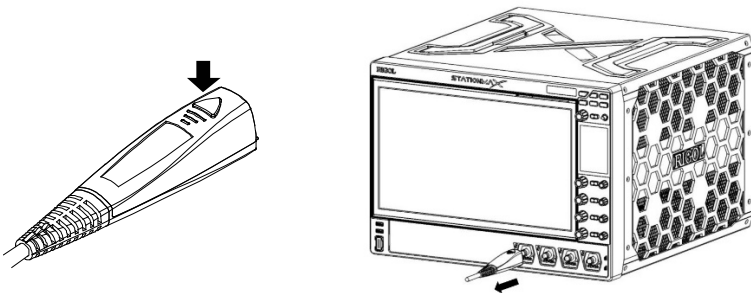

**CAUTION**

Do not twist the probe on the BNC connector of the oscilloscope. Otherwise, the probe might be damaged.

---



# To Use the Probe Head

In the **Probe Head** section, PVA8000 can be connected with 5 types of probe heads. You can easily change the probe head by using the method introduced in **To Replace Probe Accessories**. This chapter introduces how to use these probe heads respectively.

## 1. Hand-held Differential Probe Head

The hand-held differential probe head provides an effective bandwidth of more than 7 GHz. The spacing between the two probe tips can be precisely adjusted by turning the roller. You can also use the button on the probe head to make adjustment according to the existing adjustment history memory. The probe tips are replaceable, which can prolong the service life of the probe.

The structure of the hand-held differential probe head is shown in **Figure 10**.

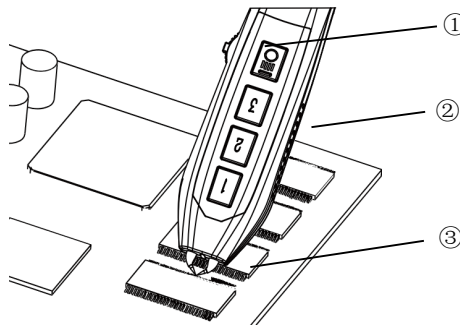



Figure 10 Hand-held Differential Probe Head

- ① Turning the roller to adjust the spacing (0.2 mm to 5.4 mm) between

the two probe tips.

- ② Hand-held differential probe head.
- ③ probe tip.

The hand-held differential probe head can be used to measure differential and single-ended signals. Button 1, 2, and 3 on the probe head has the memory function. Take Button 1 as an example. When you need to save the current position of the probe head for future use, long press this button in this position until the indicator between the probe tips blinks. Then release the button. In this way, the position of the probe tip is remembered by the probe. For the future use, once you want to adjust the probe to this specified position, just press Button 1 and then the probe tip will be adjusted

automatically to this position. The  button is a button for controlling the on/off status of the indicator located between the probe tips. In weak light environment, you'd better turn on the indicator to make measurements clear to see.

The following figure shows the operation demonstration:

Long press the roller in this direction to close the probe tips.

Press down the roller to restore the probe tips to its original position.

Long press the roller in this direction to make the tips open.

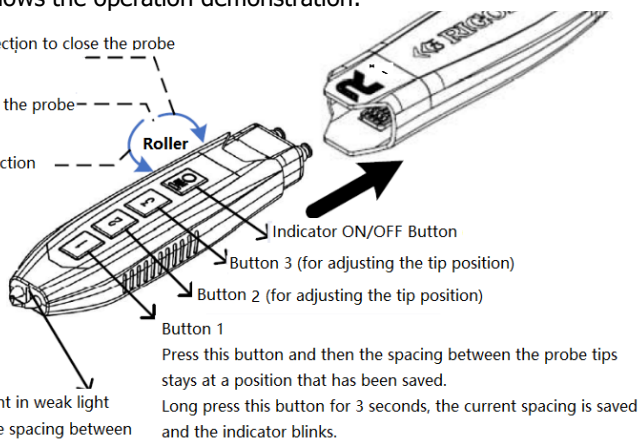

Figure 11 How to Operate the Hand-held Differential Probe Head

## 2. Hand-held Single-ended Probe Head

The hand-held single-ended probe head provides an effective bandwidth of more than 7 GHz. The spacing between the signal pin of the probe and the ground pin can be adjusted by moving or rotating the ground pin. The signal pin (hand-held single-ended) and ground pin (hand-held single-ended) are replaceable, improving its usability and prolonging the service life of the probe.

The structure of the hand-held single-ended probe head is shown in **Figure 12**.

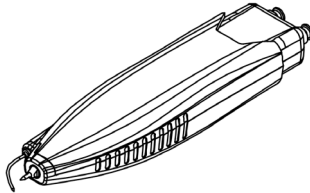

Figure 12 Hand-held Single-ended Probe Head

## 3. Solder-in Differential Probe Head

The solder-in differential probe head provides an effective bandwidth of more than 7 GHz. The replacement of the nickel wire enhances the usability of the probe and prolongs its service life.

The structure of the solder-in differential probe head is shown in **Figure 13**.

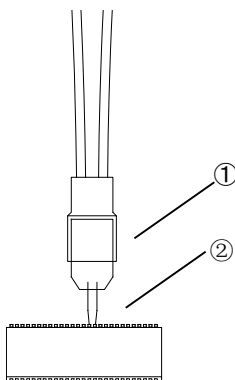

Figure 13 Solder-in Differential Probe Head

- ① Solder-in differential probe head.
- ② 0.2mm Nickel Wire (4 mm typ.).

When the points to be tested are widely spaced, the length of the nickel wire will be increased. At this point, overshoot and ringing will occur and the high-frequency response will change.

#### 4. Solder-in Single-ended Probe Head

The solder-in single-ended probe head provides an effective bandwidth of more than 5 GHz. The replacement of the nickel wire enhances the usability of the probe and prolongs its service life.

The structure of the solder-in single-ended probe head is shown in **Figure 14**.

The pin at the same side with the negative pole mark sleeve (refer to **Figure 8**) is negative.

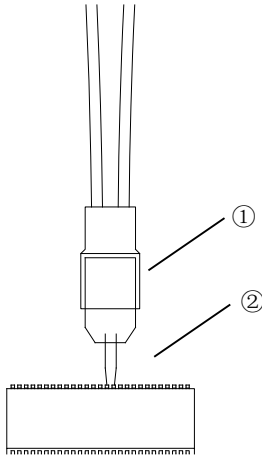

Figure 14 Solder-in Single-ended Probe Head

- ① Solder-in single-ended probe head.
- ② 0.2mm Nickel Wire (4 mm typ.).

When the points to be tested are widely spaced, the length of the nickel wire will be increased. At this point, overshoot and ringing will occur and the high-frequency response will change.

## 5. Differential Socketed Probe Head

The differential socketed probe head provides an effective bandwidth of more than 4 GHz. It is easy to plug in and out. Its service life is long.

The structure of the differential socketed probe head is as shown in **Figure 15**.

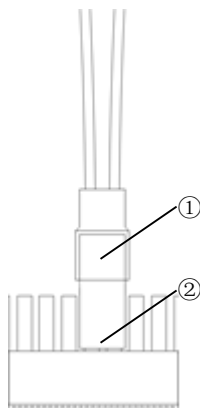

Figure 15 Differential Socketed Probe Head

- ① Differential socketed probe head.
- ② Socket.

# To Replace Probe Accessories

## 1. To replace the probe head

Take care not to damage the connecting part to avoid affecting the probe performance when replacing the probe head.

Replacing Method:

- ① Disconnect the connection between the probe and the oscilloscope.
- ② Disconnect the current probe head from the active probe amplifier.
- ③ Push the new probe head into the active probe amplifier straightly.  
When single-ended probe head is used, keep the spring contact at the same side being connected.

## 2. To replace the probe tip

The probe tip can be inserted into the probe head directly, so please note the direction and strength when removing and installing the probe tip.

## 3. To replace the nickel wire

If the nickel wire of the solder-in probe head under use becomes damaged or breaks off, you can replace a new one. The probe head nickel wire should satisfy the following size requirement, that is, the length is 4 mm (recommended value).

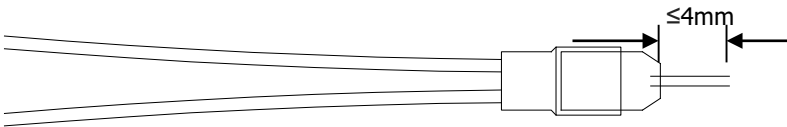

Note: If the length of the nickel wire is longer than 4 mm, the bandwidth specification of the probe will be affected. You can use the trim gauge to measure and cut the nickel wire.

## To Adjust Offset Voltage

**RIGOL** DS70000 series oscilloscope can provide offset voltage to the PVA8000 series active probe. Then the offset voltage can be output through the BNC module of the probe. The offset voltage adjusts the measured signal which exceeds the input dynamic range of the probe to within an appropriate range to ensure the measured signal's integrity.

You can adjust the offset voltage by operating the front panel menu of the oscilloscope. The operation method is as shown below.

1. Follow the instructions in **To Connect to the Oscilloscope** to connect the PVA8000 series active probe to the channel input terminal (e.g. CH1) of the DS70000 oscilloscope.
2. Open the probe offset voltage control menu of the DS70000 oscilloscope (**CH1** → **Probe** → **Bias**) and input the value with the virtual keypad.



## To Calibrate the Probe

Before using, you should calibrate the PVA8000 series active probe. Follow the procedures below to calibrate the PVA8000 active probe:

1. Connect the PVA8000 active probe to the analog channel (CH1 to CH4 of the oscilloscope, illustrations here are based on CH1).
2. Open the probe calibration control menu (front panel operation: **CH1** → **Probe** → **Calibration**), and the oscilloscope starts to calibrate the probe. The calibration will last for about 80 to 90 seconds. When the probe calibration is finished, a prompt message "Probe calibration finished!" or "Probe calibration failure!" is displayed in the user interface of the oscilloscope.

As the offset voltage of the PVA8000 series active probe is provided by the BNC module, after the first calibration, you do not need to calibrate it again before use next time.

Note: Technical specifications of the PVA8000 series active probe depend on the calibration operation. After the calibration is finished, the DC gain, offset voltage zero and offset gain will be calibrated. After inserting the probe, users can view the information about the vendor, model, serial number, and the last calibration time of the probe through the menu operation: **CH1** → **Probe**.

---

## Care and Cleaning

### Care

Do not place the probe and its accessories in places where they will be exposed to sun light for long periods of time.



---

#### **CAUTION**

Keep the probe and its accessories away from any corrosive liquid.

---

### Cleaning

Clean the probe and its accessories regularly according to their operation conditions using the method below.

1. Disconnect the probe from the oscilloscope or power source.
2. Clean the external surfaces of the probe and its accessories with a soft cloth dampened with mild detergent or water.



---

#### **WARNING**

To avoid short-circuit resulting from moisture or even personal injuries, ensure that the probe is completely dry before use.

---

# Warranty

**RIGOL** TECHNOLOGIES CO., LTD. (hereinafter referred to as **RIGOL**) warrants that the product will be free from defects in materials and workmanship within the warranty period. If a product proves defective within the warranty period, **RIGOL** guarantees free replacement or repair for the defective product.

To get repair service, please contact with your nearest **RIGOL** sales or service office.

There is no other warranty, expressed or implied, except such as is expressly set forth herein or other applicable warranty card. There is no implied warranty of merchantability or fitness for a particular purpose. Under no circumstances shall **RIGOL** be liable for any consequential, indirect, ensuing, or special damages for any breach of warranty in any case.

# Specifications

## Technical Specifications

Item	PVA8350	PVA8700
Bandwidth	>3.5 GHz	>7 GHz
Rise Time	110 ps (typ.)	70 ps (typ.)
System Bandwidth	3.5 GHz <sup>[1]</sup>	5 GHz <sup>[1]</sup>
Input Capacitance	<0.6 pF	
Input Resistance	50kΩ±2% Differential	
	25kΩ±4% Single-ended	
Input Dynamic Range	±2 V	
Input Common Mode Range	±6.25 V DC to 100 Hz	
	±1.25 V >100 Hz	
Common Mode Rejection Ratio	>40dB@1MHz	>40 dB@1 MHz
	>26dB@1GHz	>26 dB@1 GHz
	>22dB@3GHz	>20 dB@4 GHz
SR <sub>max</sub> <sup>[2]</sup>	18 V/ns Single-ended	
	30 V/ns Differential	
DC Attenuation	10:1 ±2%	
Zero Offset Error <sup>[3]</sup>	<30mV before calibration	
	<5mV after calibration	
Offset Accuracy <sup>[3]</sup>	<3% of current range before calibration	
	<1% of current range after calibration	
Input Noise	5 mVrms	
Transmission Delay	6 ns (typ.)	

Max Input Voltage	30V Peak CAT I <sup>[4]</sup>
Electrostatic Protection (HBM)	>8 kV

**General Characteristics**

<b>Environmental Conditions</b>	<b>Operating</b>	<b>Non-operating</b>
Temperature	+5°C to +40°C	-40°C to +60°C
Humidity	0 RH to 80% RH	0 RH to 90% RH
Altitude	4600m	15300m
Power Consumption	1.35W	N/A
Weights	137g±10g <sup>[5]</sup> 736g±50g <sup>[6]</sup>	
Wire Length	1 m	

- [1] System bandwidth when working with DS70000 series products.
- [2]  $SR_{max}$  of a sine wave = 2 x (Amp x Frequency);  $SR_{max}$  of a step = 0.6 x Amp/Rise Time (20% to 80%).
- [3] Typical value. The specifications would change when different scales are selected.
- [4] CAT I and CAT II Definitions  
Installation Category (Overvoltage Category) I: signal level, special equipment or parts of equipment, telecommunication, electronic, etc., with smaller transient voltages than installation category (Overvoltage Category) II.  
Installation Category (Overvoltage Category) II: local level, appliance, portable equipment etc., with smaller transient voltages than installation category (Overvoltage Category) III.
- [5] The weight of the PVA8000 probe with the hand-held differential probe head.
- [6] The weight of the PVA8000 series active probe kit with the probe bag.